

204\_018

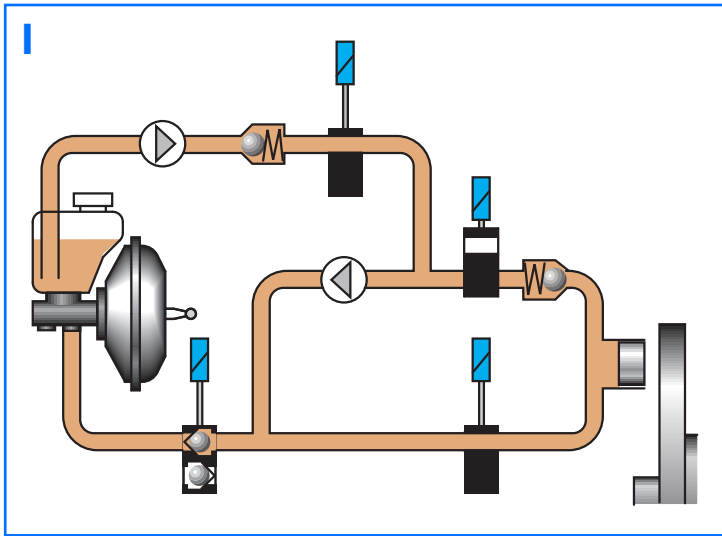

204\_036

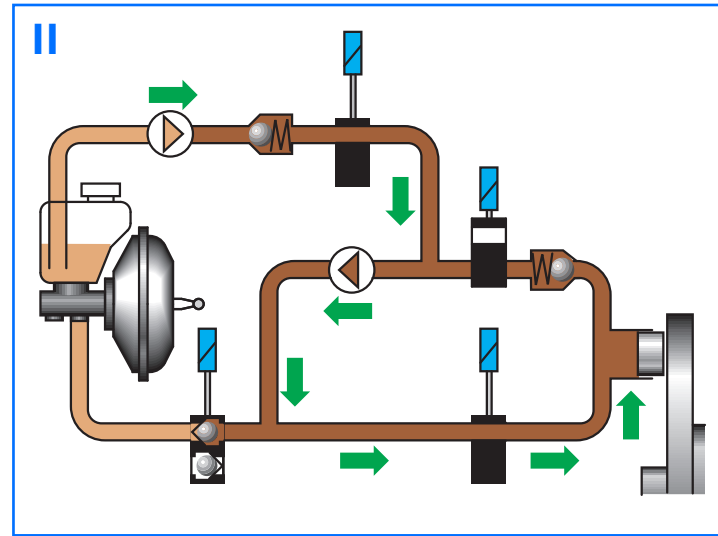

204\_037

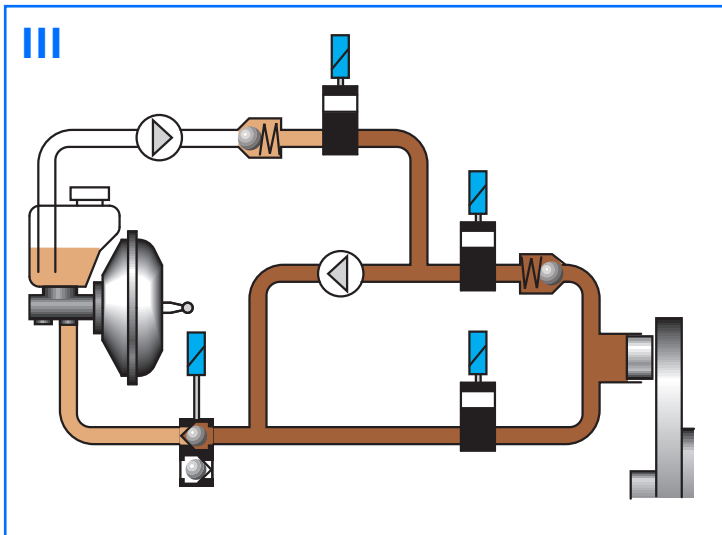

204\_038

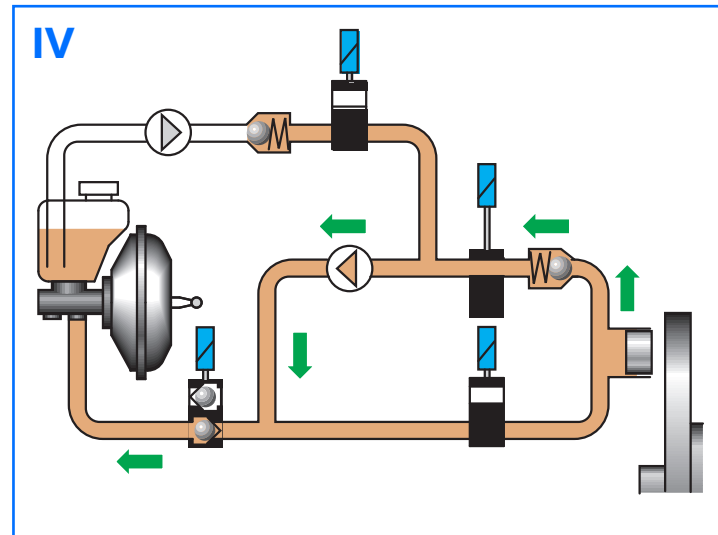

204\_039

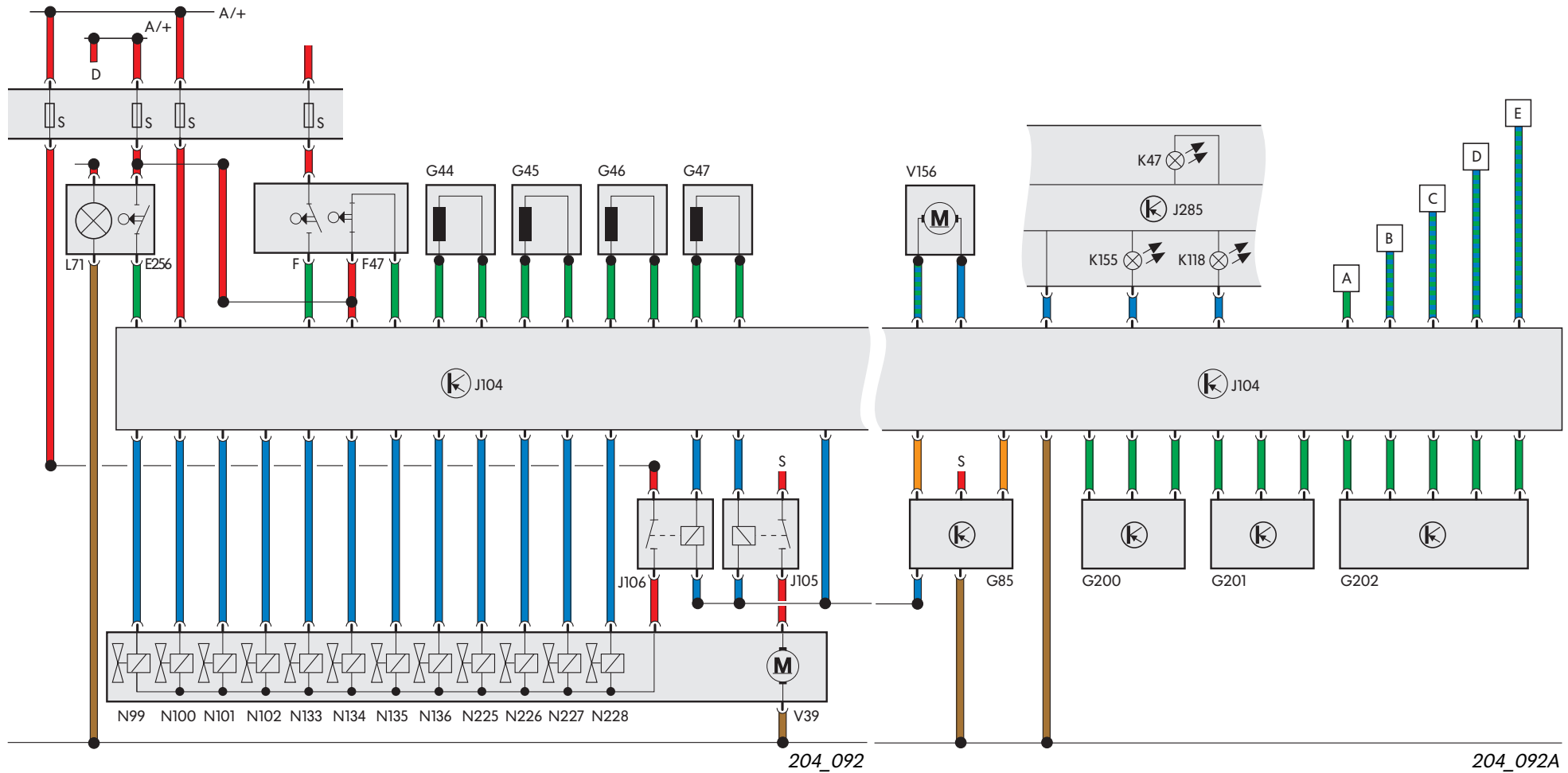

## Service Training

K-VK-12

07/98

BOSCH

SSP 204\_004

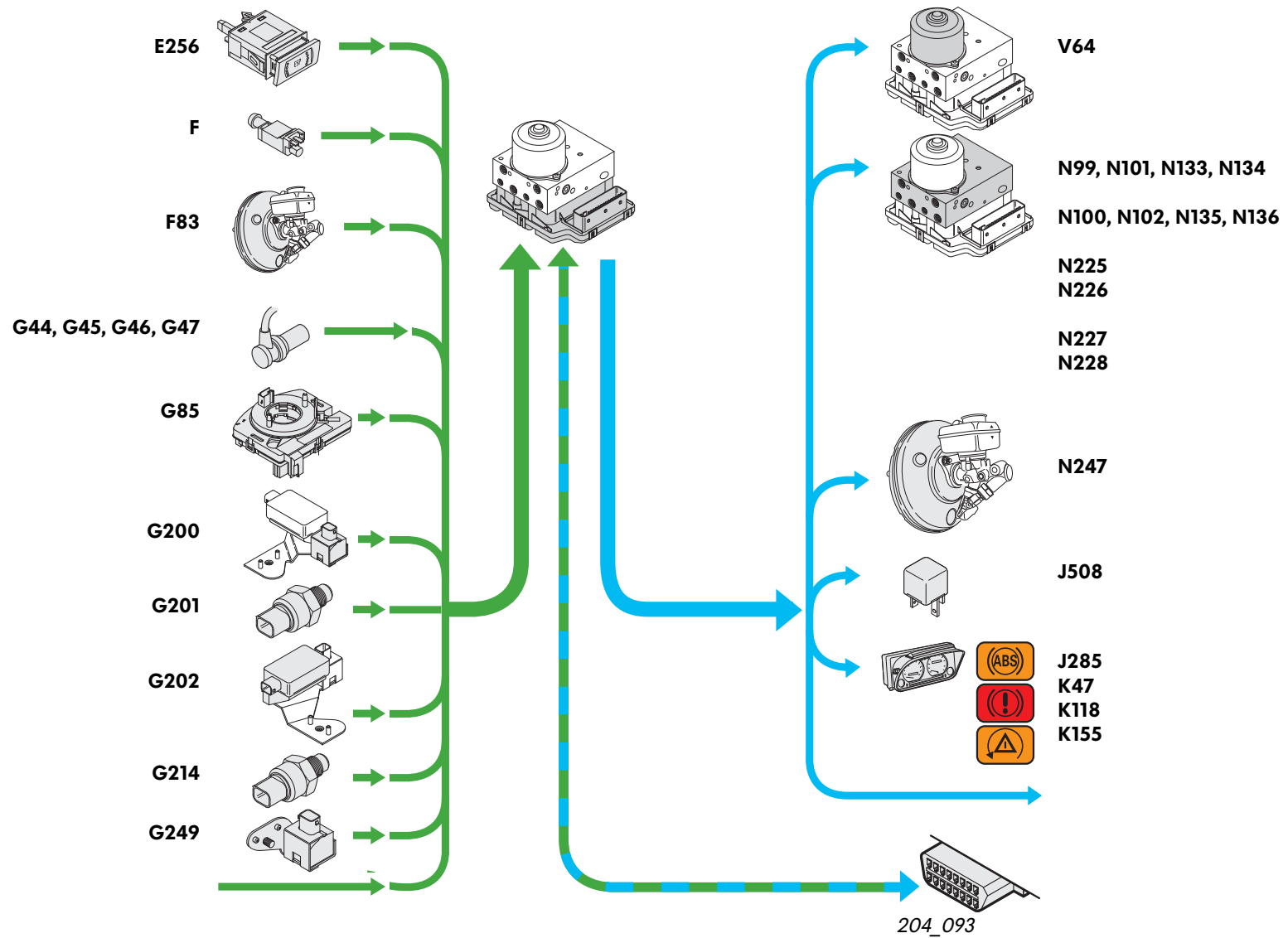

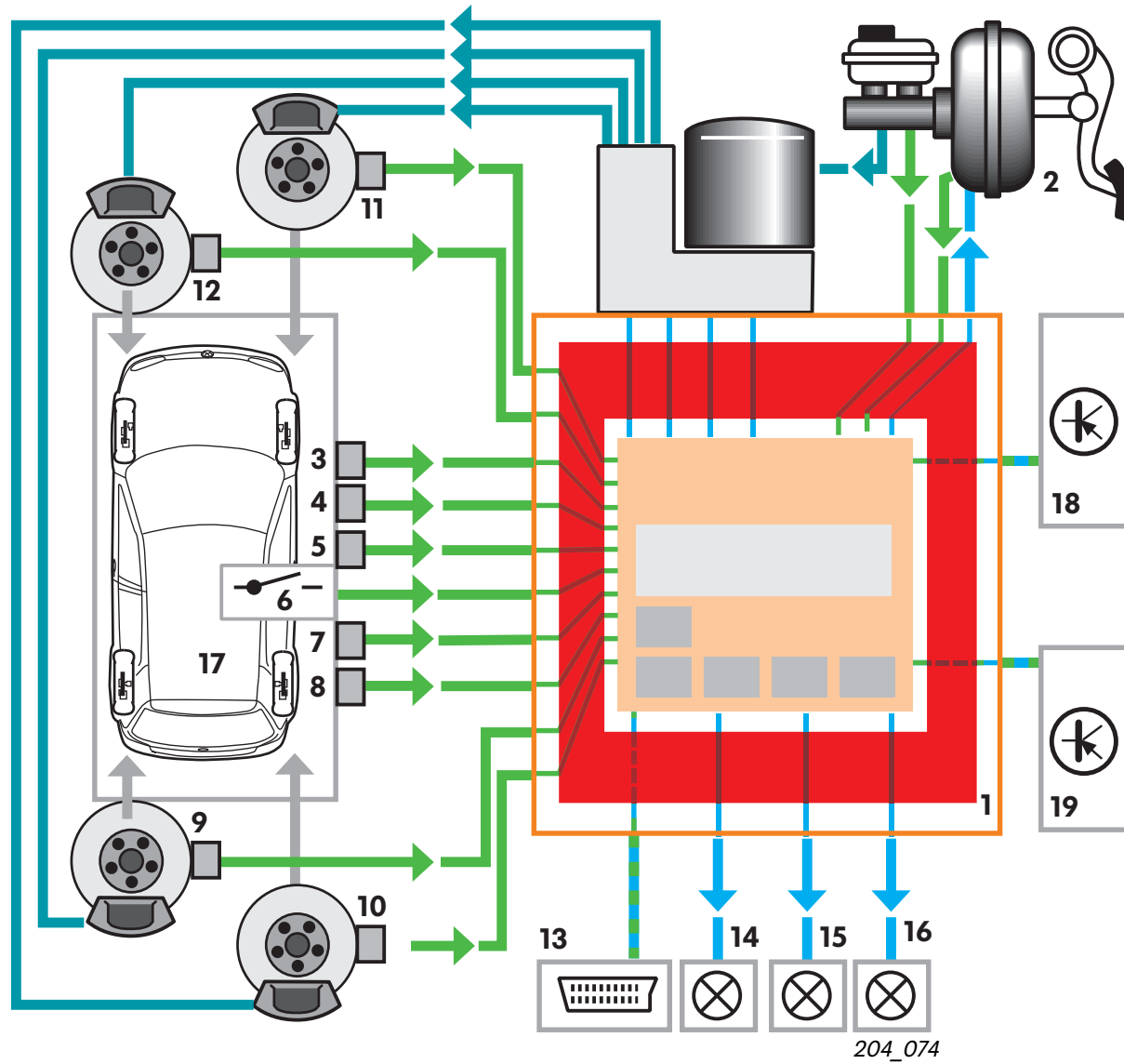

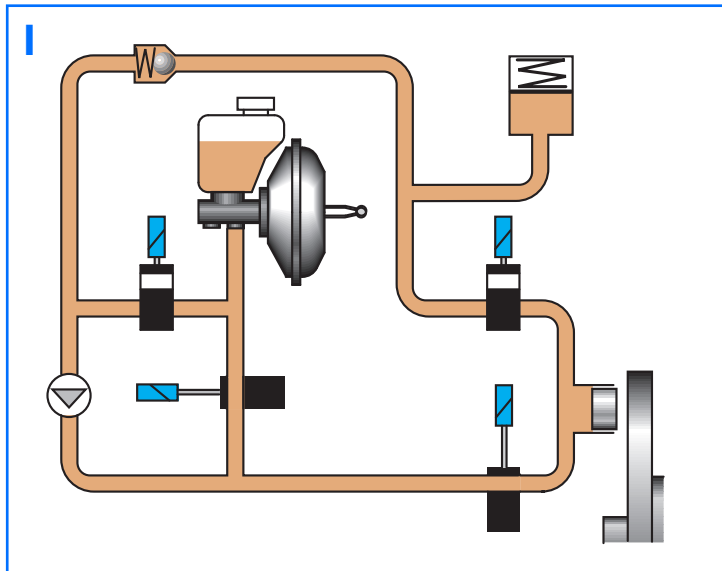

204\_080

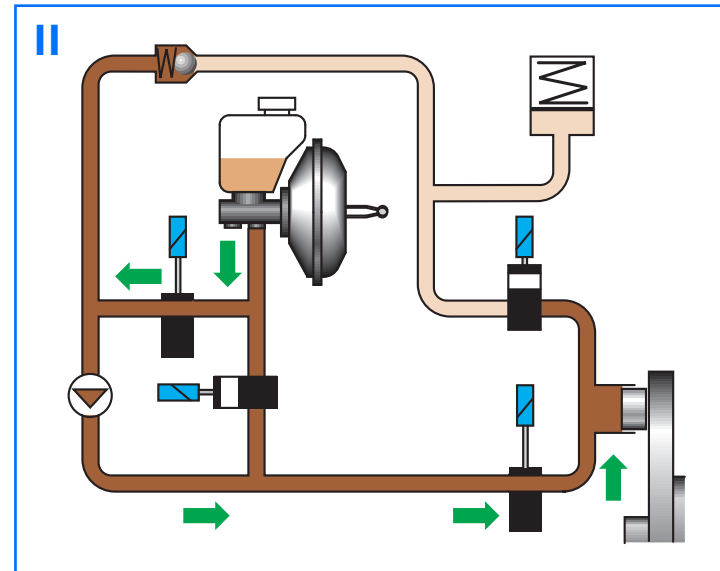

204\_081

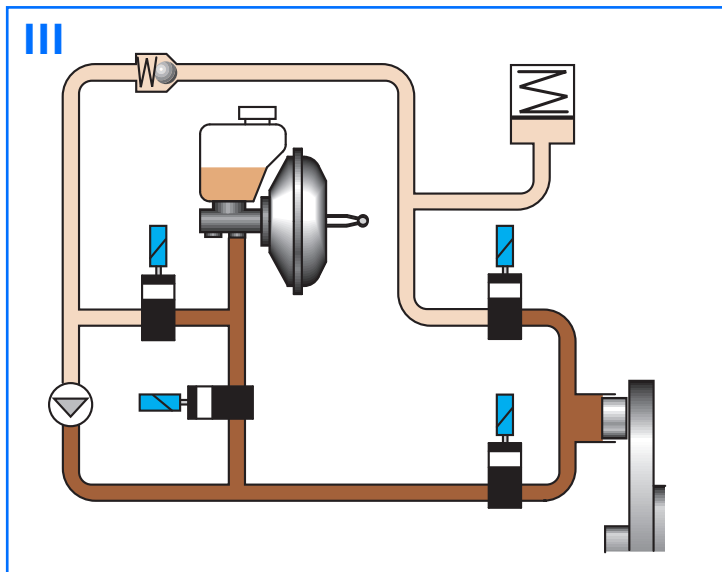

204\_082

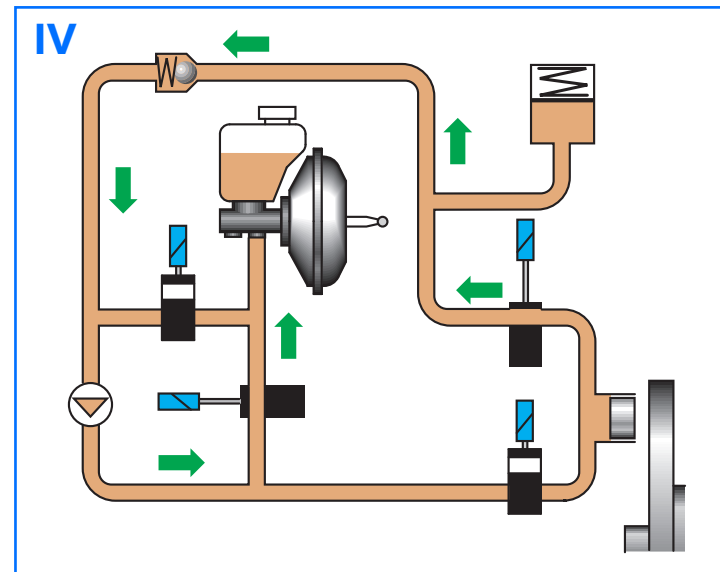

204\_083

